

**G3-PLC L3/L4 Interoperability Test
Procedure Manual**

HATS Conference

(Promotion Conference of Harmonization of Advanced Telecommunication Systems)

Multimedia Communication Test Implementation Liaison Committee

Revision history

Version	Date of revision	Description	Person in charge
1.0	Nov 27, 2013	Creation of the initial version of this ANNEX document	Akiyama, Kato

The copyright to this document is exclusively owned by HATS Conference.
Copying, reproducing, modifying, diverting, transmitting online or distributing online the contents of this document in whole or in part without prior consent of HATS Conference

Contents

1. BACKGROUND AND OBJECTIVE	5
1-1. Background.....	5
1-2. Objective	5
1-3. Scope	5
2. DEFINITION	6
2-1. Term	6
2-2. Abbreviations.....	6
3. PRECONDITIONS FOR THE TESTS	7
3-1. Standards to be complied with.....	7
3-2. Preconditions.....	8
The preconditions for these connection tests are as shown below.	8
3-3. Components.....	8
3-4. Prior confirmation test.....	9
4. INTEROPERABILITY TESTS	10
4-1. Test configuration.....	10
4-2. Physical connection method	11
4-3. Target interface	11
4-4. Target product category	11
4-5. Target profile	11
4-5-1. Test profile	11

4-6. Test environment	11
4-6-1. ICMPv6 Informational Message Interoperability Test	12
4-6-2. Unicast Interoperability Test	12
4-6-3. Multicast Interoperability Test	12
4-7. Test procedure	13
4-8. Test items	14
4-8-1. ICMPv6 Informational Message Interoperability Test	14
4-8-2. Unicast Interoperability test	14
4-8-3. Multicast Interoperability Test	14
4-9. Test procedures	15
4-9-1. ICMPv6 Informational Message Interoperability Test	15
4-9-2. Unicast Interoperability test	17
4-9-3. Multicast Interoperability Test	19
4-10. Test items and result evaluation	22
4-11. Summary of the test results	24
4-12. Additional test items	24
5. HANDLING OF THE TEST RESULTS AND THE ISSUES TO BE STUDIED IN FUTURE	25
5-1. Handling of the test results	25
5-2. Miscellaneous	25
EXHIBIT 1 :G3-PLC INTEROPERABILITY TEST (ICMPV6 INFORMATIONAL MESSAGE CONNECTION) CHECK SHEET	26
EXHIBIT 2 : G3-PLC INTEROPERABILITY TEST (UNICAST INTEROPERABILITY) CHECK SHEET	27
EXHIBIT 3 :G3-PLC INTEROPERABILITY TEST (MULTICAST INTEROPERABILITY) CHECK SHEET	28

1. Background and objective

1-1. Background

While the construction of the smart community is accelerated with a view to the improvement of the energy demand environment, the smart houses equipped with the smart meters and energy controls system (HEMS), which enable the comprehensive energy control, are increasingly adopted and spread. It is extremely important to connect the HEMS household facilities and equipment, as the public interfaces closest to the consumers who select a wide variety of products and systems, for maximizing the convenience for them and offering diverse energy-saving devices and services. As the G3-PLC was adopted as an alternative, it is urgently required to build the system and environment for assuring the interoperability between devices.

1-2. Objective

By adopting the G3-PLC as the interface to assure the interoperability between devices, the adoption and spread of G3-PLC devices are promoted. To promote the adoption of G3-PLC devices in the actual environment, it is indispensable to build the interoperability between products while it is very important to check the connectivity by conducting the mutual connection tests.

This test procedure manual defines the procedure for checking the interoperability of layers 3 and 4, for which no certification program has been established, and allows the interoperability to be assured over all the layers by concurrently using the mutual connectivity tests for other layers, for which the mutual connectivity has been already established.

1-3. Scope

The scope of this procedure shall be as follows:

- (1) This procedure applies to the interoperability tests of layers 3 and 4 based on the TTC Standard JJ-300.11 "Home network communication interface for ECHONET Lite (ITU-T G.9903 Narrow-band OFDM PLC)".
 - (2) Both PAN Coordinator and node are subject to the connection tests.
-

2. Definition

2-1. Term

Term	Description
Connection test	In this document, opposite connection of two terminal devices to perform communication tests.

2-2. Abbreviations

Abbreviations	Description
DUT	Abbreviation for Device Under Test
PSK	Abbreviation for Pre-Shared Key
TE	Abbreviation for Test Equipment

3. Preconditions for the tests

3-1. Standards to be complied with

Figure 3.1 shows the protocol stack of the G3-PLC communication terminal. The representative standards which should be complied with in regard to the Interoperability of this system are as shown below.

- (1) Home network communication interface for JJ-300.11 ECHONET Lite
- (2) G.9901 ITU-T G.9901 Narrowband orthogonal frequency division multiplexing power line communication transceivers-power spectral density specification
- (3) G.9903 ITU-T G.9903 Narrowband orthogonal frequency division multiplexing power line communication transceivers for G3-PLC networks
- (4) ARIB STD-T84 power line carrier communication facilities (10kHz to 450kHz)
- (5) RFC2460 Internet Protocol Version 6 (IPv6)
- (6) RFC4291 IP Version 6 Addressing Architecture
- (7) RFC4443 Internet Control Message Protocol (ICMPv6) for the Internet Protocol Version 6 (IPv6) Specification
- (8) RFC768 User Datagram Protocol (UDP)
- (9) IEEE Std 802.15.4™ Wireless Medium Access Control (MAC) and Physical Layer (PHY) Specification for Low-Rate Wireless Personal Area Networks (WPANs)
- (10) RFC4944 Transmission of IPv6 Packet over IEEE 802.15.4 Networks (6LowPAN)
- (11) RFC6282 Compression Format for IPv6 Datagrams over IEEE 802.15.4-Based Networks
- (12) RFC2464 Transmission of IPv6 Packets over Ethernet Networks
- (13) The ECHONET Lite Specification Version 1.10

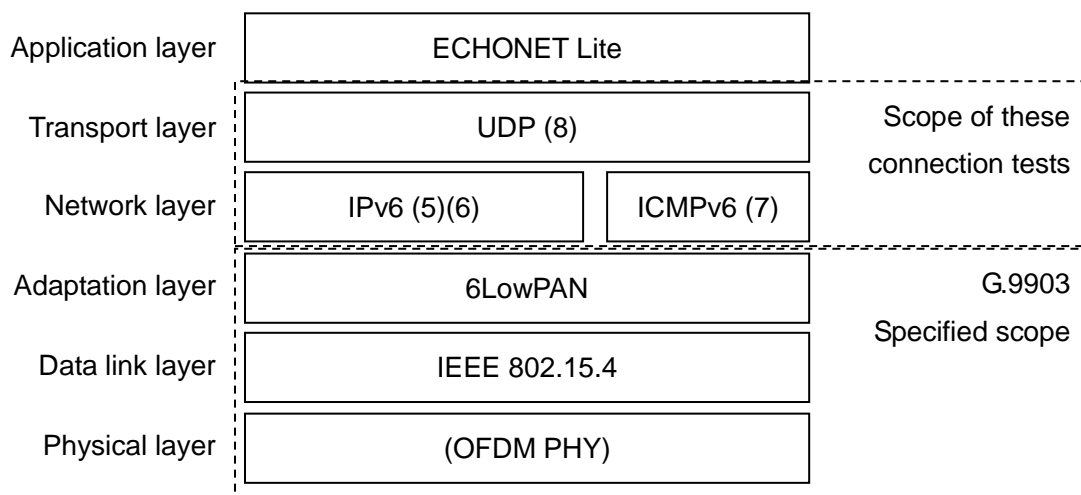

Figure 3.1 G3-PLC communication terminal protocol stack

3-2. Preconditions

The preconditions for these connection tests are as shown below.

- (1) The specifications of the interface showing connection conditions must be obtained by each relevant company.
- (2) The connection tests have been conducted for the scope specified by G.9903 shown in Figure 3.1
- (3) Participants shall disable encryption function on their DUT and set a PSK given in this document at tests.
- (4) Participants shall bring their DUT which have been passed the conformance test (See ANNEX HATS-M-107.1-V1.0)
- (5) Participants for Route-B shall set ID_S ('SM'+Route B authentication ID) and ID_P ('HEMS'+Route B authentication ID) based on Route B authentication ID (0~9 and A~F 32 octets ASCII characters) given in this document at tests.

Example: When Route B authentication ID is '0023456789ABCEDF0011223344556677',

ID_S ='SM0023456789ABCEDF0011223344556677'

ID_P='HEMS0023456789ABCEDF0011223344556677'

Also PSK is derived from Route-B Password given in this document at tests. The PSK is lower order 16 octets of the output created by using SHA-256 in the hash function on the capitalized Password character string.

Example: When the Password is "0123456789ab"

PSK = LSBytes16(SHA-256("0123456789AB"))

= 0xf58d060cc71e7667b5b2a09e37f602a2

3-3. Components

The environment of this connection test consists of the components shown in the following table.

Table 3-3-1 Components

Component name	Description
PAN Coordinator	Terminal device connected to one end of opposite connection in these connection tests, establishes PAN network on the G3-PLC Pseudo Environment and assigns/distributes information such as PAN ID and network address which is required for the following terminals to perform communications.
Opposite terminal	Terminal device connected to another end of opposite connection, which participates in the PAN network established by PAN Coordinator.
TE	Tester consisting of Packet Analyzer

3-4. Prior confirmation test

With regard to the components involved in these tests, the normal operation between the in-house components must be confirmed according to the test items specified in Chapter 4.

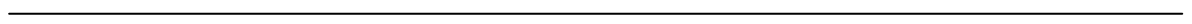

4. Interoperability tests

4-1. Test configuration

This test procedure manual does not thoroughly define the entire G3-PLC services but defines the procedure for testing the interoperability of the essential services. The contents are going to be increased and improved as necessary.

Specifically, the connection tests are conducted by using the test composition shown below. Test configuration includes two DUTs. One DUT will operate as PAN Coordinator, while the other DUT will operate as the opposite terminal belonging to the PAN network which consists of PAN Coordinator. On these tests, the TE consisting of the Packet Analyzer shall be used to observe the packets that are transmitted from both DUTs.

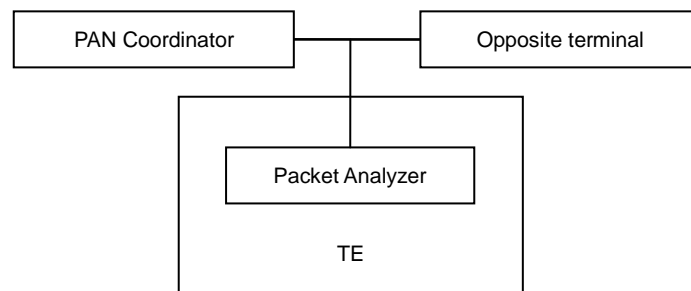

Figure 4.1.1 Scope of the G3-PLC Pseudo Test Environment

The following connections are tested with regard to the PAN Coordinator and opposite terminal.

- 1) ICMPv6 Informational Message interoperability (PAN Coordinator - opposite terminal)
 - 2) Interoperability via unicast (PAN Coordinator - opposite terminal)
 - 3) Interoperability via multicast (PAN Coordinator - opposite terminal)
-

4-2. Physical connection method

DUT can send and receive no-voltage G3-PLC signal. For mutual physical connection, use the 2P 100V outlet with no voltage applied. The DUT has to use other power supply. Figure 4.2.1 shows an image of this connection state.

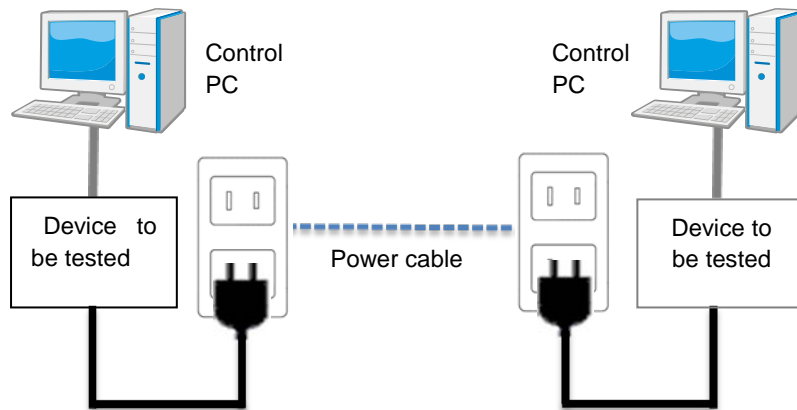

Fig. 4.2.1 Physical connection image

4-3. Target interface

The target interface is the home network communication interface for ECHONET Lite specified in JJ-300.11.

- (1) Protocol IPv6

4-4. Target product category

The product category subject to the connection tests comprises the terminals shown below, which are equipped with the interfaces mentioned above.

- (1) Category
Home network communication terminals
- (2) An example of the terminal styles: PLC wireline terminals

4-5. Target profile

4-5-1. Test profile

Nothing in particular

4-6. Test environment

(Preparation for the tests: The common items to be prepared for the tests)

- (1) The following 3 interoperability tests are conducted.
-

- 1) ICMPv6 Informational Message Interoperability Test
- 2) Unicast Interoperability Test
- 3) Multicast Interoperability Test

4-6-1. ICMPv6 Informational Message Interoperability Test

The connection of the components for the ICMPv6 Informational Message Interoperability Test is as shown in Figure 4.6.1 below.

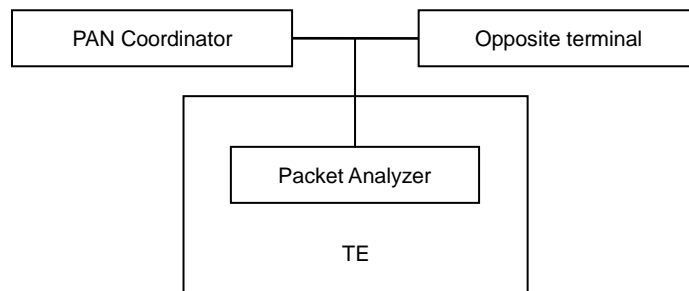

Figure 4.6.1 G3-PLC connection test environment (ICMPv6 Informational Message Interoperability Test)

The connection test should be conducted within the same network consisting of connection between PAN coordinator and the opposite terminal.

4-6-2. Unicast Interoperability Test

The connection of the components for the Unicast Interoperability Test is as shown in Figure 4.6.2 below.

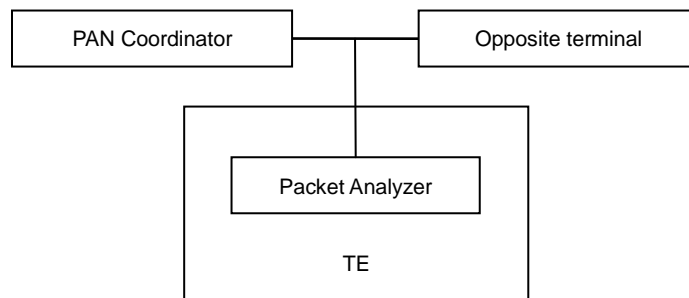

Figure 4.6.2 G3-PLC connection test environment (Unicast Interoperability Test)

The connection test should be conducted within the same network consisting of connection between PAN coordinator and the opposite terminal.

4-6-3. Multicast Interoperability Test

The connection of the components for the Unicast Mutual Connection Test is as shown in Figure 4.6.3 below.

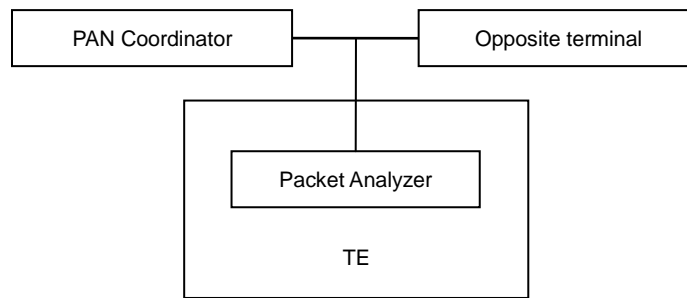

Figure 4.6.3 G3-PLC connection test environment (Multicast Interoperability Test)

The connection test should be conducted within the same network consisting of connection between PAN coordinator and the opposite terminal.

4-7. Test procedure

- (1) Carry the devices to be tested into the test site specified by the bureau.
- (2) Make arrangement to ensure that the product of one participating company is paired with the product of every other participating company.

There are 3 test scenarios as shown below.

Scenario 1: ICMPv6 Informational Message Interoperability Test

Scenario 2: Unicast Interoperability Test

Scenario 3: Multicast Interoperability Test

Implement tests in order of Scenario 1, Scenario 2 and Scenario 3. In principle, the mutual connections between in-house products are supposed to be tested on its own account. Thus, the products of the same company are not paired with each other on the test site.

4-8. Test items

4-8-1. ICMPv6 Informational Message Interoperability Test

The following test items are implemented.

Table 4-8-1 ICMPv6 Informational Message Interoperability Function Items

No.	Test items	Reference sequence examples
1	PAN registration (MAC 16-bit short address assign)(*)	G.9903 Amd.1 9.4.4.2.2 6LoWPAN bootstrapping procedures
2	ECHONET Lite node start instance list notice (*)	ECHONET Lite, Part 2, Chapter 4, 4.3.1
3	ICMPv6 Echo Request response	This test procedure manual, 4-9-1
4	ICMPv6 Echo Reply reception	This test procedure manual, 4-9-1
5	ICMPv6 ECHO Request transmission	This test procedure manual, 4-9-1

*: Acceptable only if checked once while the test is in progress.

4-8-2. Unicast Interoperability test

The following test items are implemented.

Table 4-8-2 Unicast Interoperability Function Items

No.	Test items	Reference sequence examples
1	PAN registration (MAC 16-bit short address assign)(*)	G.9903 Amd.1 9.4.4.2.2 6LoWPAN bootstrapping procedures
2	ECHONET Lite property value read service	ECHONET Lite, Part 2, Chapter 4, 4.2.3.3
3	GET frame normal response	This test procedure manual, 4-9-2

4-8-3. Multicast Interoperability Test

The following test items are implemented.

Table 4-8-3 Multicast Interoperability Function Items

No.	Test items	Reference sequence examples
1	PAN registration (MAC 16-bit short address assign)(*)	G.9903 Amd.1 9.4.4.2.2 6LoWPAN bootstrapping procedures
2	ECHONET Lite node start instance list notice (*)	ECHONET Lite, Part 2, Chapter 4, 4.3.1
3	INF_REQ frame normal response	This test procedure manual, 4-9-3
4	INF_REQ frame unacceptable response	This test procedure manual, 4-9-3

*: Acceptable only if checked once while the test is in progress.

4-9. Test procedures

The following 2 procedures are specified according to the test scenario.

4-9-1. ICMPv6 Informational Message Interoperability Test

ICMPv6 Informational Message interoperability functions: Table 4-8-1, No. 1 to No. 4

- (1) Start up the PAN Coordinator.
- (2) Start up the opposite terminal. Check that the association is established with the PAN Coordinator and the PAN ID, 16-bit short MAC address are assigned.
- (3) Check that the ECHONET Lite node start instance list notice is transmitted from the opposite terminal.
- (4) Check that the opposite terminal receives the Echo Requests sent by the PAN Coordinator to the opposite terminal as shown in Table 4-9-1 and the Echo Replies shown in Table 4-9-2 are sent out to the PAN Coordinator. After that, check that the PAN Coordinator has no response for the Echo Reply and can continue the subsequent test operations.

Table 4-9-1 ICMPv6 Echo Request packet contents

Packet fields		Contents
MAC	Destination	MAC address of the opposite terminal
	Source	MAC address of the PAN Coordinator
IPv6	Destination	IPv6 address of the opposite terminal
	Source	IPv6 address of the PAN Coordinator

Table 4-9-2 ICMPv6 Echo Request packet contents

Packet fields		Contents
MAC	Destination	MAC address of the PAN Coordinator.
	Source	MAC address of the opposite terminal
IPv6	Destination	IPv6 address of the PAN Coordinator terminal
	Source	IPv6 address of the opposite terminal

- (5) Receive the Echo Reply sent to other than the opposite terminal as shown in Table 4-9-3 and confirm that operation of the opposite terminal is not affected after that. After that, check that the the PAN Coordinator has no response for the Echo Reply and can continue the subsequent test operations.

Table 4-9-3 ICMPv6 Echo Reply packet contents

Packet fields		Contents
MAC	Destination	Other than MAC address of the opposite terminal
	Source	MAC address of the PAN Coordinator
IPv6	Destination	Other than IPv6 address of the

		opposite terminal
	Source	IPv6 address of the PAN Coordinator

- (6) Switch over the opposite terminal with the PAN Coordinator and repeat steps (1) to (5) shown above.

4-9-2. Unicast Interoperability test

Unicast Interoperability functions: Table 4-8-2, No. 1 to No. 3

- (1) Start up the PAN Coordinator.
- (2) Start up the opposite terminal Check that the association is established with the PAN Coordinator and the PAN ID, 16-bit short MAC address, etc. are assigned.
- (3) Send Get (unicast) from PAN Coordinator to the opposite terminal as shown in Table 4-9-4, and confirm that the received terminal sends Get_Res as shown in Table 4-9-5.

Table 4-9-4 Get packet contents

Packet fields		Contents
MAC	Destination	MAC address of the opposite terminal
	Source	MAC address of the PAN Coordinator
IPv6	destination	IPv6 address of opposite terminal
	source	IPv6 address of the PAN Coordinator
UDP	Destination	3610
ECHONET Lite	EHD1	0x10
	EDH2	0x81
	TID	0x1234
	SEOJ	0x0EF001
	DEOJ	0x0EF001
	ESV	0x62
	OPC	1
	EPC	0x80
	PDC	0
EDT	N/A	

Table 4-9-5 Get_Res packet contents

Packet fields		Contents
MAC	Destination	MAC address of the PAN Coordinator
	Source	MAC address of the opposite terminal
IPv6	Destination	IPv6 address of the PAN Coordinator
	Source	IPv6 address of opposite terminal
UDP	Destination	3610
ECHONET Lite	EHD1	0x10
	EDH2	0x81
	TID	0x1234
	SEOJ	0x0EF001
	DEOJ	0x0EF001

	ESV	0x72
	OPC	1
	EPC	0x80
	PDC	0x01
	EDT	0x30 or 0x31

4-9-3. Multicast Interoperability Test

Multicast interoperability functions: No. 1 to No. 4 of Table 4-8-3

- (4) Start up the PAN Coordinator.
- (5) Start up the opposite terminal. Check that the association is established with the PAN Coordinator and the PAN ID, 16-bit short MAC address are assigned.
- (6) Check that the ECHONET Lite node start instance list notice is transmitted from the opposite terminal.
- (7) Check that the opposite terminal receives the INF_REQ (multicast) sent by the PAN Coordinator to the opposite terminal as shown in Table 4-9-6 and the INF (multicast) shown in Table 4-9-7 are sent out.

Table 4-9-6 INF_REQ packet contents

Packet fields		Contents
MAC	Destination	FFFF
	Source	MAC address of the PAN Coordinator.
IPv6	Destination	FF02::1
	Source	IPv6 address of the PAN Coordinator.
UDP	Destination	3610
ECHONET Lite	EHD1	0x10
	EDH2	0x81
	TID	0x1234
	SEOJ	0x0EF001
	DEOJ	0x0EF001
	ESV	0x63
	OPC	1
	EPC	0x8A
	PDC	0
	EDT	N/A

Table 4-9-7 INF packet contents

Packet fields		Contents
MAC	Destination	FFFF
	Source	MAC address of the opposite terminal
IPv6	Destination	FF02::1
	Source	IPv6 address of the opposite terminal
UDP	Destination	3610
ECHONET Lite	EHD1	0x10
	EDH2	0x81

	TID	0x1234
	SEOJ	0x0EF001
	DEOJ	0x0EF001
	ESV	0x73
	OPC	1
	EPC	0x8A
	PDC	3
	EDT	ECHONET consortium manufacturer code of the opposite terminal

- (8) Check that the opposite terminal receives the INF_REQ (multicast) as shown in Table 4-9-8 and the INF_SNA (unicast) shown in Table 4-9-9 are sent out to the PAN Coordinator.

Table 4-9-8 INF_REQ packet contents

Packet fields		Contents
MAC	Destination	FFFF
	Source	MAC address of the PAN Coordinator.
IPv6	Destination	FF02::1
	Source	IPv6 address of the PAN Coordinator.
UDP	Destination	3610
ECHONET Lite	EHD1	0x10
	EDH2	0x81
	TID	0x1234
	SEOJ	0x0EF001
	DEOJ	0x0EF001
	ESV	0x63
	OPC	1
	EPC	0xFF (The EPC not supported by the terminal)
	PDC	0
EDT	N/A	

Table 4-9-9 INF_REQ packet contents

Packet fields		Contents
MAC	Destination	MAC address of the PAN Coordinator.
	Source	MAC address of the opposite terminal
IPv6	Destination	IPv6 address of the PAN Coordinator.
	Source	IPv6 address of the opposite terminal
UDP	Destination	3610
ECHONET Lite	EHD1	0x10
	EDH2	0x81

	TID	0x1234
	SEOJ	0x0EF001
	DEOJ	0x0EF001
	ESV	0x53
	OPC	1
	EPC	0xFF (Equal to the value of the INF)
	PDC	0
	EDT	N/A

- (9) Check that the PAN Coordinator receives the INF_SNA (unicast) and the PAN Coordinator has no response for the Echo Reply and can continue the subsequence test operations.

4-10. Test items and result evaluation

This test procedure manual defines the test items only under the normal communication conditions and the checking due to the change in the mode (i.e. the parameters, etc.) in the middle of the communication is optional. The test is supposed to be passed on condition that the contents of the test procedures specified in *4-9. Test procedures* and the items defined in Table 4-10-1 shall be checked normally.

Table 4-10-1 Observation points and verdicts.

No	Observation Point	Verification	Relation between test items and verdicts		
			4-8-1. ICMPv6 Informational Message Interoperability Test	4-8-2. Unicast Interoperability test	4-8-3. Multicast Interoperability Test
1	PAN registration	Check that the association is established with the PAN Coordinator by following the test procedure.	Yes Exhibit 1 No. 1, 6	Yes Exhibit 2 No. 1, 4	Yes Exhibit 3 No. 1, 5
2	Instance list notice	Check that the ECHONET Lite node start instance list notice is transmitted by the Multicast by following the test procedure.	Yes Exhibit 1 No. 2, 7	Yes Exhibit 2 No. 2, 5	Yes Exhibit 3 No. 2, 6
3	ICMPv6 Echo Request/Reply check	Check that ICMPv6 Echo Requests and Replies are transmitted and received normally by following the test procedure.	Yes Exhibit 1 No. 3, 4, 5, 8, 9, 10	No	No
4	Unicast transmission / reception check	Check that the Unicast communication is available by following the test procedure.	No	Yes Exhibit 2 No. 3, 6	Yes Exhibit 3 No. 4, 8
5	Multicast transmission / reception check	Check that the Multicast communication is available by following the test procedure	No	No	Yes Exhibit 3 No. 3

4-11. Summary of the test results

After the test is complete, the results are checked via the PAN Coordinator, the opposite terminal and the TE, and the check sheet attached as Exhibit 1, 2 or 3 is filled in by each participating company. Also, if any error is identified while the test is in progress, it is preferable to indicate the conditions (i.e. the phenomena, causes, measures, etc.) in the check sheet within a scope which does not cause any inconvenience.

If you wish to conduct the test again, fill in the MEMO space of the check sheet accordingly.

4-12. Additional test items

The test items may be added or revised as necessary.

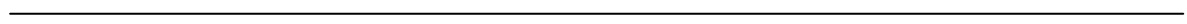

5. Handling of the test results and the issues to be studied in future

5-1. Handling of the test results

The results of the connection tests must be used to draw up the procedure manual for conducting the main test in future.

Also, the test procedures, methods, locations, results, etc. should be recorded to ensure that the future tests are conducted more efficiently.

5-2. Miscellaneous

With regard to the issues concerning the standard regulation details, etc. identified by conducting the tests, the possibility for applying the feedback for standardization activities should be examined as necessary.

Exhibit 1 :G3-PLC Interoperability Test (ICMPv6 Informational Message Connection) Check Sheet

[Filled in by]

Company/agency	
Responsible person	
Phone number	
Fax number	

Time and date of the test [] : to []
 Location of the test []
 PAN Coordinator [Company/agency: Model:]
 Opposite terminal [Company/agency: Model:]
 TE [Company/agency: Model:]

No.	Items to be checked	Criteria	Results ("Good" or "Bad")	Remarks (Problems, etc.)
1	PAN Coordinator	PAN registration		Acceptable only if checked once while the test is in progress.
2		Instance list notice		Acceptable only if checked once while the test is in progress.
3		ICMPv6 Echo Request response		
4		ICMPv6 Echo Reply reception		
5	Option	ICMPv6 Echo Request transmission		

6	Opposite terminal	PAN registration		Acceptable only if checked once while the test is in progress.
7		Instance list notice		Acceptable only if checked once while the test is in progress.
8		ICMPv6 Echo Request response		
9		ICMPv6 Echo Reply reception		
10	Option	ICMPv6 Echo Request transmission		

- MEMO -

[Details of the failures mentioned above]
